

3D IMAGING



Passion to innovate

An introduction from our President

Planmeca Viso™	4
Planmeca Viso™ family	6
Planmeca ProMax® 3D family.....	8
Unique 3D combination – an industry first	10
Intelligent solutions for the best image quality.....	12
Pioneering low dose 3D imaging	14
Ease of operation.....	16
Real-time jaw movement – in 3D	18
2D and 3D imaging with one sensor.....	20
Quality cephalometry for orthodontics.....	22
Professionals proudly present the Planmeca ProMax® 3D family.....	24
Planmeca ProMax® 3D s.....	26
Planmeca ProMax® 3D Classic	28
Planmeca ProMax® 3D Plus	30
Planmeca ProMax® 3D Mid.....	32
Planmeca ProMax® 3D Max.....	34
Planmeca Romexis® – one software for all your needs.....	36
The most advanced 3D software	38
The complete implant workflow.....	40
Share images and expertise online	42
Access to unique X-ray device data	43
Stand out with colour	44
Technical specifications	44

“Welcome to the future of digital imaging. It gives me great pleasure to introduce you to our world-leading 3D X-ray units and **Planmeca Romexis®** imaging software – with a pioneering combination of 3D images that takes you closer for an even greater understanding of what your patients need.

I’m extremely proud of our product innovations, and for nearly 50 years we’ve worked closely with dental professionals to set new standards in our field. What makes us a bit different is that all core product development and manufacturing takes place in Finland – ensuring exceptional quality and unmatched attention to detail at every stage of the process.

This brings us to our X-ray product family, taking care of all your 2D and 3D imaging needs in a single unit. Each product is a true all-in-one unit, offering easy-to-use controls and incredible patient comfort. We have a dedicated team of in-house R&D professionals behind the scenes, all determined to make the best possible products for you and your patients. Therefore I am thrilled to invite you to discover our complete selection of advanced 3D solutions.”

Heikki Kyöstiä
President and founder
Planmeca Group



Planmeca Viso™

The next generation has arrived

Planmeca Viso™ is an ideal combination of premium image quality and high-end usability. It possesses all the qualities of a world class CBCT unit – and more. The unit is an impressive step forward in the evolution of cone beam imaging. It fulfils the needs of demanding maxillofacial imaging in all clinical environments, from private clinics to large hospitals.



Maximum
volume size
Ø30 x 30 cm

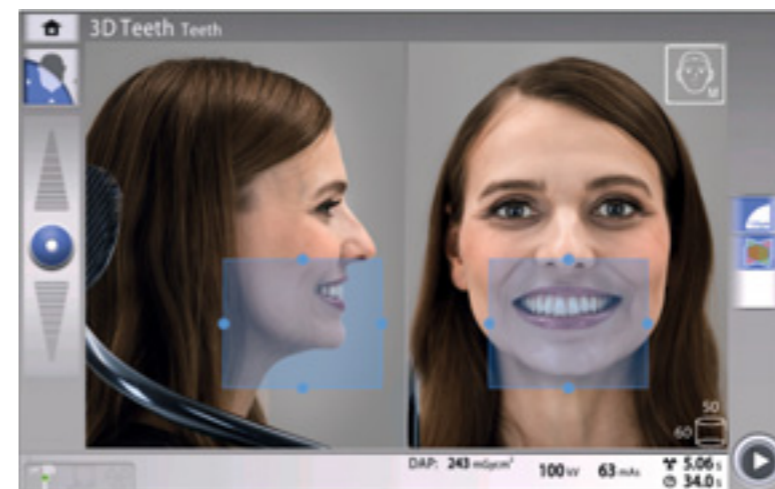

Live virtual FOV positioning

Patient positioning is done directly from the CBCT unit's control panel utilising integrated cameras and a live patient view. Users can freely adjust the size and location of the FOV with the tip of their fingers.

Freely adjustable volume

Planmeca Viso™ offers a wide volume selection to cover all clinical needs – from single tooth to full skull imaging. The volume size can be adjusted freely. The unit's remarkable 3D sensor is also fully capable of 2D imaging.

Planmeca ProFace® photos with 4 integrated cameras

Planmeca Viso introduces a new way of capturing Planmeca ProFace® facial photos. The unit's sensor has four built-in cameras and LED light strips for capturing highly detailed 3D photographs. They can be combined with model scans of patients to enrich 3D treatment plans.

Planmeca PlanID™ connectivity

With integrated RFID connectivity, Planmeca Viso opens up new possibilities for patient and user identification.

Intelligent patient support

The unit's occipital support provides stability without compromising patient comfort.



FOV size and location can still be readjusted on the scout view.

Planmeca Viso™ family

Our **Planmeca Viso™** CBCT imaging unit family now consists of two models – both offering exceptional image quality, numerous cutting-edge features, and premium usability. The units are capable of three-dimensional imaging, as well as panoramic, extraoral bitewing, and cephalometric imaging. The next generation of CBCT imaging is here in full force!



Planmeca Viso™ G5

Single 20 x 10 cm scans covering the entire jaw area can be acquired without the need for stitching. The volume size can be adjusted freely from 3 x 3 to 20 x 17 cm.



Planmeca Viso™ G5

Planmeca Viso™ G7

Single 19 x 30 cm scans covering the entire maxillofacial area can be acquired without the need for stitching. The volume size can be adjusted freely from 3 x 3 to 30 x 30 cm.



Planmeca Viso™ G7

	G5	G7
Maximum volume without stitching	Ø200 x 100 mm	Ø300 x 190 mm
Maximum volume with vertical stitching	Ø200 x 170 mm	Ø300 x 300 mm
Planmeca CALM™ movement artefact correction	✓	✓
Planmeca Ultra Low Dose™ imaging	✓	✓
Tube voltage 120 kV	✓	✓
Endodontic mode	✓	✓
3D dental programs	✓	✓
3D ENT programs	✓	✓
3D face photo	✓	✓
3D models scan	✓	✓
4D jaw motion	✓	✓
2D panoramic imaging	✓	✓
Cephalometric imaging, one-shot	✓	✓

Planmeca ProMax® 3D family

True all-in-one units for all your imaging needs

Planmeca ProMax® 3D is a product family consisting of exceptional all-in-one units. With three different types of three-dimensional imaging – as well as panoramic, extraoral bitewing and cephalometric imaging – these intelligent products can meet all your maxillofacial imaging needs.



Planmeca ProMax® 3D s



Planmeca ProMax® 3D Classic



Planmeca ProMax® 3D Plus



Planmeca ProMax® 3D Mid



Planmeca ProMax® 3D Max

	3D s	3D Classic	3D Plus	3D Mid	3D Max
Planmeca CALM™ movement artefact correction	✓	✓	✓	✓	✓
Planmeca Ultra Low Dose™ imaging	✓	✓	✓	✓	✓
Tube voltage option 120 kV			✓	✓	✓
Endodontic mode	✓	✓	✓	✓	✓
3D dental programs	✓	✓	✓	✓	✓
3D ENT programs			✓	✓	✓
3D face photo	✓	✓	✓	✓	✓
3D models scan	✓	✓	✓	✓	✓
Suresmile certification		✓		✓	✓
4D jaw motion				✓	✓
2D panoramic imaging	✓	✓	✓	✓	✓
Cephalometric imaging, scanning	✓	✓	✓	✓	
Cephalometric imaging, one-shot	✓	✓	✓	✓	

	3D s	3D Classic	3D Plus	3D Mid	3D Max
Maximum volume without stitching	Ø50 x 80 mm or Ø80 x 50 mm	Ø80 x 80 mm	Ø200 x 100 mm	Ø200 x 100 mm	Ø230 x 160 mm
Extended volume without stitching		Ø110 x 80 mm			
Maximum volume with horizontal stitching	150 x 100 x 50 mm	150 x 100 x 80 mm			
Maximum volume with vertical stitching				Ø200 x 170 mm	Ø230 x 260 mm

Unique 3D combination – an industry first

We're the first company to combine three different types of 3D data with one X-ray unit. Our 3D family brings together a Cone Beam Computed Tomography (CBCT) image, 3D face photo and 3D model scan into one 3D image – using the same advanced software. This 3D combination creates a virtual patient in 3D, helping you with all your clinical needs.



3D X-ray image

Cone Beam Computed Tomography (CBCT) is an X-ray imaging technology where a large number of 2D images are taken of a patient from different angles. A 3D volumetric image is then calculated from these 2D projections. The resulting images can be viewed with our advanced imaging software from any angle, including the axial, coronal, sagittal and cross-sectional planes.

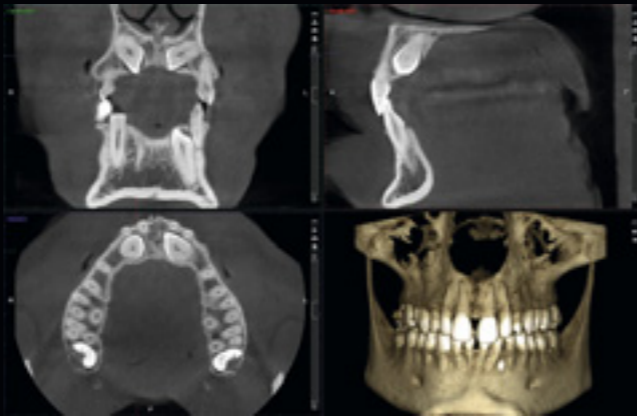

3D face photo

Planmeca ProFace® is an exclusive 3D face photo system available for all of our 3D X-ray units. This pioneering integrated system produces a realistic 3D face photo and CBCT image in a single imaging session. You can also take a separate 3D face photo without exposing your patient to any radiation.



3D model scan

You can use all of our 3D X-ray units to scan both impressions and plaster casts – an exciting feature that was an industry first for our CBCT units. With our advanced Planmeca Romexis® software, the digitised models are available immediately and stored for later use.



See more than ever before



Intelligent solutions for the best image quality

Our intelligent high-tech solutions and algorithms guarantee an ideal imaging geometry, perfect usability, and crystal-clear images free from noise and artefacts.

SCARA technology

The precise, free-flowing, computer-controlled SCARA (*Selectively Compliant Articulated Robot Arm*) arm construction can produce any movement pattern required. This enables accurate and reliable volume positioning and volume diameter adjustment, reducing the amount of radiation your patients are exposed to.



120 kV tube voltage

120 kV tube voltage enables optimised image quality for challenging targets – reducing artefacts and ensuring higher contrast images.

Optimised imaging modes for different needs

- **Low dose mode** captures an image with a minimal dose of radiation. Ideally suited for orthodontic, pediatric and sinus studies. Voxel size 400 or 600 μm
- **Normal mode** is the best choice for most common imaging needs. Voxel size 200 μm
- **High definition mode** is designed for imaging of small objects, such as ear bones. Voxel size 150 μm
- **Braces protocol** offers optimised exposure settings for imaging patients with brackets. Voxel size 150 μm
- **High resolution** provides more detail when necessary. Voxel size 100 μm
- **Endodontic mode** offers the best resolution with the smallest size. Voxel size 75 μm

Certified by OraMetrix
suressmile
to be sure.



Never miss a shot with Planmeca CBCT units

Movement, metal artefacts, and small voxel sizes are generally recognised as challenges to CBCT image quality. With Planmeca CBCT units and their advanced image enhancement options, you can rise above these concerns and succeed every time. The options can either be selected preventively before imaging or utilised afterwards to achieve reliable results. The choice is yours!

Movement artefact correction with Planmeca CALM™

Planmeca CALM™

- Iterative movement correction algorithm
- Eliminates the need for retakes
- Cancels the effects of patient movement
- Excellent when imaging more lively patients

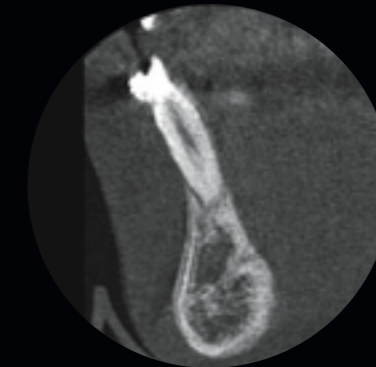

Without movement artefact correction

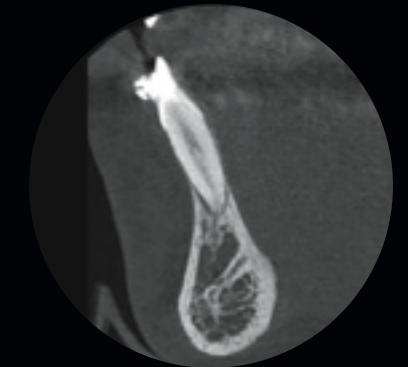

With the Planmeca CALM™ movement removal algorithm

Metal artefact reduction with Planmeca ARA™

Planmeca ARA™

- Reliable algorithm for artefact-free images
- Removes shadows and streaks caused by metal restorations and root fillings
- Tried and tested – the results of extensive scientific research

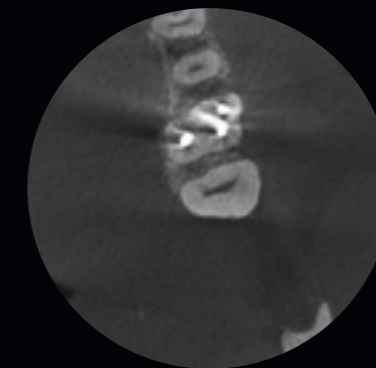

Without artefact removal



With the Planmeca ARA™ artefact removal algorithm

Noise removal with Planmeca AINO™

Planmeca AINO™

- Noise-free images without losing valuable details
- Allows lower exposure values by reducing noise
- Improves image quality when using small voxel sizes (e.g. in the endodontic imaging mode)
- Enabled by default when using the Planmeca Ultra Low Dose™ imaging protocol

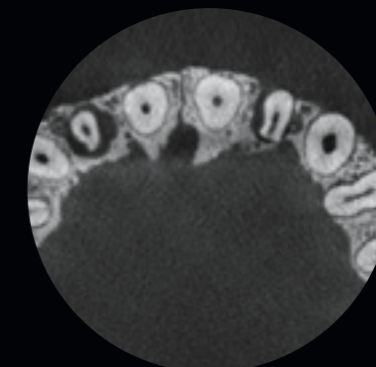

Without noise removal

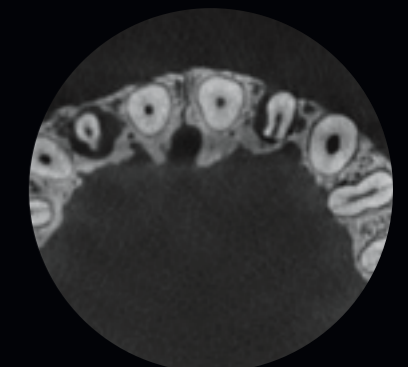

With the Planmeca AINO™ noise filter

Pioneering low dose 3D imaging

Our 3D X-ray units offer a unique **Planmeca Ultra Low Dose™** imaging protocol that enables CBCT imaging with an even lower patient radiation dose than standard 2D panoramic imaging.

More information, less radiation

Planmeca Ultra Low Dose™ can be used with all voxel sizes and in all imaging modes from Normal to Endodontic mode. Using the Planmeca Ultra Low Dose protocol reduces the effective patient dose by an average of 77% without a statistical reduction in image quality*.

The unique and pioneering imaging protocol is based on intelligent 3D algorithms developed by Planmeca. Our 3D imaging system always allows the clinician to choose the optimal balance between image quality and dose, based on the ALARA principle.

* Study of Orthodontic Diagnostic FOVs Using Low Dose CBCT protocol (Ludlow, John Barrett and Koivisto, Juha).

planmeca.com/ULD-poster

Ideal for many clinical cases

The Planmeca Ultra Low Dose protocol has proven to be ideal for many clinical cases.

- Orthodontics:
 - Defining the amount of bone around the root
 - Localising unerupted and impacted teeth before orthodontic treatment
 - Defining orthodontic landmarks for cephalometric analysis
- Post-operative and follow-up images in maxillofacial surgery
- Airway studies
- Sinus studies
- Implant planning

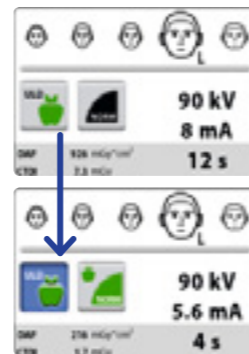
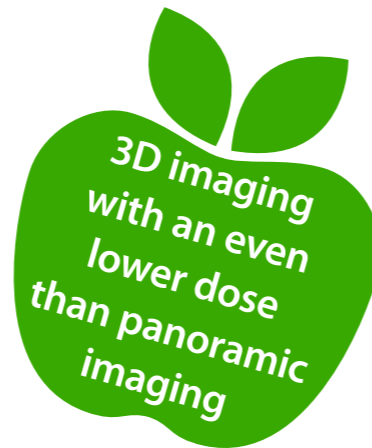

Planmeca ProMax® 3D Mid

- FOV Ø 200 x 170 mm / Voxel size 600 µm
- Effective patient dose 14.7 µSv

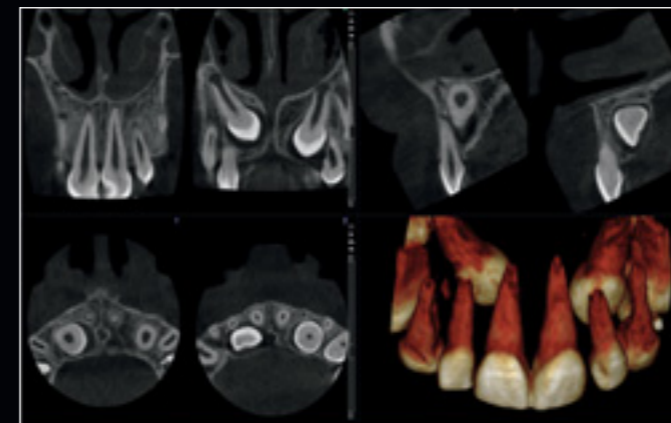

Planmeca ProMax® 3D Classic

- FOV Ø 40 x 50 mm / Voxel size 150 µm
- Effective patient dose 14.4 µSv

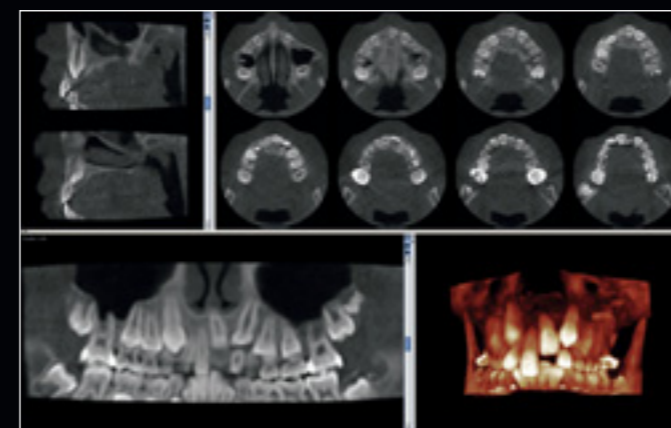

Planmeca ProMax® 3D Max

- FOV Ø 85 x 50 mm / Voxel size 400 µm
- Effective patient dose 4.0 µSv



Planmeca ProMax® 3D Mid

- FOV Ø 200 x 170 mm / Voxel size 600 µm
- Effective patient dose 29.2 µSv

The Planmeca Ultra Low Dose™ protocol has changed 3D imaging completely

We at MESANTIS® 3D DENTAL-RADIOLOGICUM produce about 7,500 CBCT images per year at eight locations in Germany.

Our main concern in X-ray imaging is to reduce the possible radiation dose as much as is reasonably achievable (ALARA principle). Traditional digital 2D X-rays at an orthodontist's clinic usually have an effective dose ranging between 26–35 µSv (ICRP 2007). Conventional CBCT images of the head with modern CBCT equipment show an effective dose ranging between 49–90 µSv.

The latest image protocol with a specific associated algorithm is called the **Planmeca Ultra Low Dose™** protocol. In medical terms, it allows radiologists to adjust imaging parameters individually according to the clinical needs of each case. The mA-values, in particular, can be individually adjusted and reduced for each patient, as it is required according to all international scientific guidelines. Therefore, it is possible to further reduce the effective dose

significantly by using the Planmeca Ultra Low Dose protocol. Depending on the field of view, nowadays CBCT equipment with a Planmeca Ultra Low Dose algorithm has an effective dose between 4 to 22 or 10 to 36 µSv.

Our patients and referring colleagues are always happy to hear that the effective dose for certain indications is now even lower than in traditional 2D X-ray imaging. Since last year we have been able to replace the common CBCT protocols with the Planmeca Ultra Low Dose protocol.

At MESANTIS® 3D DENTAL-RADIOLOGICUM in Germany, the Planmeca Ultra Low Dose imaging protocol is used either with a small or large field of view. Using the new protocol, a lot of patients can benefit from improved 3D diagnostics without being exposed to a higher radiation dose.

Prof. Dr. Axel Bumann

Prof. Dr. Bumann states that he has not received any financial reward or other benefit for this interview.



Prof. Dr. Axel Bumann
DDS, PhD, Orthodontist,
Oral surgeon, Oral and
Maxillofacial Radiology,
MESANTIS® 3D
DENTAL-RADIOLOGICUM

Ease of operation

Our 3D X-ray units are known across the world for incredible ease of use and exceptional patient comfort. A relaxed patient means a smooth imaging workflow and the best quality images.



User-friendly Planmeca ProTouch™ control panel

- Clear and straightforward graphical user interface guides you smoothly through the work process
- Pre-programmed sites and exposure values for different image types and targets save you time and allow you to focus on your patients
- The control panel can also be operated remotely from the imaging workstation



Open patient positioning

- Effortless positioning with open-face architecture
- Unrestricted view of your patient
- No claustrophobic feeling for your patient
- Fine adjustment using positioning lasers and joystick
- Verify correct positioning with a scout image
- Easy wheelchair accommodation with side-entry access

Easy imaging with ready-designed protocols

- Imaging protocols designed for specific diagnostic tasks, areas, or target sizes
- Appropriate volume size, resolution, and exposure values
- Automatic selection and adjustment of the target position
- Reduced volume sizes for child patients to prevent unnecessary radiation

Scout images for easy positioning

Scout images and 2D views help positioning and can even be used for preliminary diagnosis.

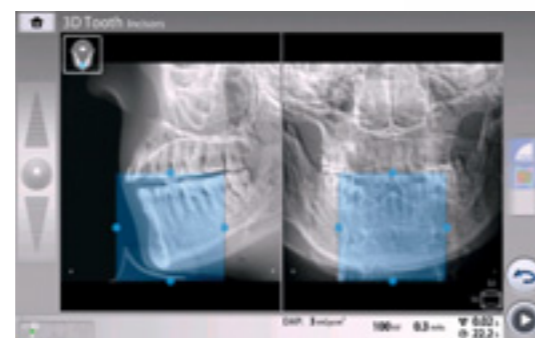

Real-time jaw movement – in 3D

Planmeca 4D™ Jaw Motion is the only true CBCT integrated solution for tracking, visualising, and analysing jaw movement in 3D. It offers incomparable visualisation of mandibular 3D movements in real-time – creating a fourth dimension in diagnostics.

Key features:

- The only CBCT integrated jaw tracking solution
- Track, visualise, and record jaw movement in 3D
- Visualise movements in the Planmeca Romexis software in real time
- Record movements for later use and analysis
- Measure and visualise the movement paths of points of interest in frontal, sagittal, and axial movement graphs and in 3D
- Align digital dental models with a CBCT image for improved visualisation
- Export movement and measurement information to 3rd party software for analyses and treatment planning



Key components of Planmeca 4D™ Jaw Motion

Planmeca 4D™ Jaw Motion adds a new dimension to 3D data by visualising a patient's jaw movement. First, a CBCT image (e.g. a Planmeca Ultra Low Dose™ image) is acquired with a Planmeca 3D unit with the patient wearing dedicated tracking devices. Integrated Planmeca ProFace® cameras are then used to track lower jaw movements in relation to the upper jaw. All movements are visualised, analysed, and stored to the Planmeca Romexis® imaging software in real time.

Applications:

Due to its capability to visualise mandibular jaw and condyle movement, Planmeca 4D Jaw Motion can be a supporting tool for:

- Temporomandibular (TMD) examinations
- Preoperative planning and postoperative treatment verifications
- Articulator programming



2D and 3D imaging with one sensor

Our advanced imaging system uses the same sensor for both 2D and 3D imaging, allowing you to enjoy a hassle-free workflow. The unique Autofocus feature enables practically error-free patient positioning and reduces the need for retakes. The result is high-quality and easily reproducible images – every time.



2D programs

Standard: Basic panoramic programs	Standard panoramic Lateral TMJ (closed & open) PA TMJ (closed & open) PA sinus
Standard	Child (Paediatric) mode for each standard and optional program to reduce the dose
Optional	Horizontal and vertical segmenting for panoramic program
Optional	True Bitewing
Optional: Advanced panoramic programs	Interproximal panoramic Orthogonal (perio) panoramic Lateral-PA TMJ Lateral multiangle TMJ PA multiangle TMJ PA linear sinus Lateral sinus

2D SmartPan™ – unique panoramic imaging

Our advanced SmartPan™ imaging system uses the same 3D sensor also for 2D panoramic imaging.

SmartPan produces 9 different parallel panoramic layers with an about 2 mm shift and one autofocus layer.

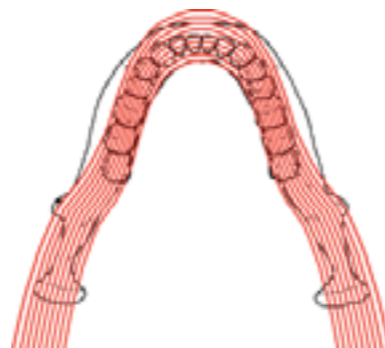

Better diagnostic value with extraoral bitewings



True Bitewing program, adult



True Bitewing program, 5-year-old child

- Ideal for all patients – no sensor positioning required
- Consistently opens interproximal contacts, giving better diagnostic value
- Larger diagnostic area than in intraoral modalities
- More clinical data: canine to third molar
- Enhanced clinical efficiency – takes less time and effort than conventional intraoral bitewings
- Enhanced patient experience and comfort – eliminates gagging



Quality cephalometry for orthodontics

Our exceptional equipment and advanced software have been designed to meet all your orthodontic needs.

Cephalometric imaging with Planmeca 3D X-ray units

- The functional and easy-to-use head positioner ensures accurate positioning for all cephalometric projections
- The carbon fibre ear posts and nasal positioner are extremely stable, hygienic, and transparent to radiation
- The unit automatically aligns itself to take cephalometric exposures and then selects a corresponding collimator
- The rotating tube head in the 3D unit eliminates the need to remove the 3D sensor
- Dedicated collimation options for paediatric imaging

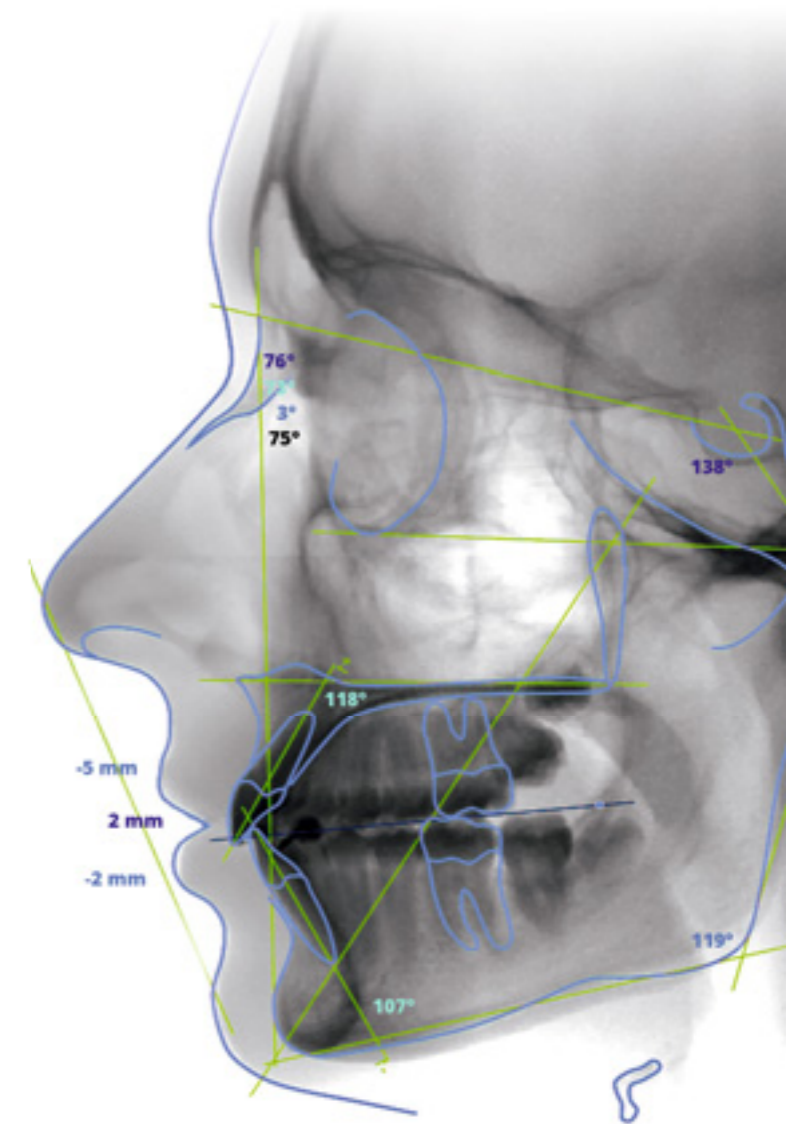

Two equipment options:

One-shot Planmeca ProCeph™ cephalostat

- Effective one-shot cephalostat
- Short exposure time – no motion artefacts, low patient dose
- Image sizes from 18 x 20 cm to 30 x 25 cm
- Available for all Planmeca 3D X-ray units

Scanning Planmeca ProMax® cephalostat

- Digital cephalostat that scans your patient's head horizontally using a narrow X-ray beam with an extremely low effective dose of radiation
- Exceptional flexibility in image formats, with field sizes of up to 30 x 27 cm

Easier and more accurate than ever before

Two options for cephalometric analyses:

Planmeca Romexis® Cephalometric Analysis module

Take advantage of the Planmeca Romexis® Cephalometric Analysis module's wide range orthodontic and orthognathic tools.

- Automatic landmark identification
- Tools for creating cephalometric analyses, superimpositions, and surgical treatment plans (VTO) in minutes
- Fully customisable analyses, norms, and reports
- Microsoft Excel export and import function
- Compatible with the Windows operating system

Online automatic analysis service

Acquire cephalometric analyses regardless of time and place with the Planmeca Romexis® automatic cephalometric analysis service.

- Online automatic cephalometric tracing in a few seconds
- Over 50 analyses available for download immediately after tracing
- Direct link from the Planmeca Romexis 2D module for ordering analyses

Professionals proudly present the Planmeca ProMax® 3D family



Which one is right for you?

Planmeca ProMax® 3D s

Planmeca ProMax® 3D s is an ideal 3D unit for capturing small details. It is perfect for single implant, endodontic, and wisdom tooth cases.

Planmeca ProMax® 3D Classic

The Planmeca ProMax® 3D Classic imaging sensor covers the whole dentition area, so the unit gives a clear view of the mandible and maxilla.

Planmeca ProMax® 3D Plus

The newest member in our 3D family, Planmeca ProMax® 3D Plus, offers a wide variety of different volume sizes and is a great choice for any imaging need.

Planmeca ProMax® 3D Mid

Thanks to its wide volume size selection, Planmeca ProMax® 3D Mid handles a wide range of diagnostic tasks without compromising best practices.

Planmeca ProMax® 3D Max

Planmeca ProMax® 3D Max is a dedicated 3D imaging device that produces all required volume sizes when diagnosing the maxillofacial region – from the smallest special cases to images of the entire head.

The interviewed have not received any financial compensation or other benefit for the interviews that follow.

Planmeca ProMax® 3D s



Long-term cooperation with Planmeca

Ari Mäkelä

Licentiate in Dentistry
Dental Care Center Janne
Järvenpää, Finland

"We purchased a Planmeca ProMax® 3D s for our dental clinic several years ago. Before that, we had equipped our clinic with five Planmeca dental units, so it was only natural to continue the cooperation with Planmeca also on the X-ray side. Also, several radiologists recommended Planmeca's 3D units to us for their high quality.

We use the unit for implant cases, for lower third molar surgery, and for endodontic cases – particularly in difficult infection

cases of teeth with multiple roots. Personally, I use the Planmeca Romexis® 3D Implant Planning module the most. It's very practical as I can virtually place the implants myself in the software.

The unit itself is very easy to use – our whole staff uses it, although mainly dentists take 3D images. Positioning is effortless and images are of high quality. And the unit's design is stylish and refined.

I would definitely recommend the unit to others. We have just taken the new sensor into use and I am very satisfied with the image quality. And the feedback from consulting radiologists has been good as well."



Chinese hospital chose Planmeca ProMax® 3D s



Sun Zhizong

Dean
Donggang City Stomatology Hospital
Liaoning, China

"I bought the Planmeca ProMax® 3D s system in September 2010. Factors influencing my decision were Planmeca's good reputation and quality-price ratio. For me, it is also important that everyday performance is excellent and if necessary, the after sales service works quickly.

I use my Planmeca 3D s system for various cases – for diagnosis in oral and maxillofacial surgery, for implantology, for

diagnosis of periodontal and dental pulp diseases, and for orthodontics. The image quality is very clear, which makes diagnosis very easy with the excellent Planmeca Romexis® software.

In implant cases, Planmeca ProMax 3D s is very important for my preparation phase. The data I get from the image of the bone structure and thickness makes the operation easy and safe for the customer.

Planmeca ProMax 3D s really adds value to my work as I can perform many different kinds of tasks quickly and efficiently."

Planmeca CALM™ movement artefact correction	✓
Planmeca Ultra Low Dose™ imaging	✓
Endodontic mode	✓
3D dental programs	✓
3D face photo	✓
3D models scan	✓
2D panoramic imaging	✓
Cephalometric imaging, scanning	✓
Cephalometric imaging, one-shot	✓

Volume sizes

Ø80 x 50 mm
Ø50 x 80 mm
Ø50 x 50 mm
2x Ø80 x 50 mm
2x Ø50 x 80 mm
2x Ø50 x 50 mm
3x Ø80 x 50 mm
3x Ø50 x 80 mm
3x Ø50 x 50 mm

Planmeca ProMax® 3D Classic



Finnish dental clinic chooses Planmeca ProMax® 3D Classic

Dr Pekka Nissinen

GPD
West Vantaa Dental Clinic, Finland

"We decided to purchase a **Planmeca ProMax® 3D Classic 8x8** for our clinic as we wanted to start taking our own CBCT images and not have to send our patients elsewhere to have their 3D X-rays taken. In such cases, there is always the risk that the treatment process will suffer due the patient's own lack of activity. Now we have our own radiologist and things have gone very smoothly. We also have two surgeons working with us, as we do a lot of implant treatments and treat also difficult endodontic cases."

Implant case acceptance has skyrocketed

"After acquiring the Planmeca ProMax 3D Classic, the amount of implant cases treated at our clinic has increased considerably. Patients are always amazed when we offer to take their 3D images straight away. The unit is also especially suited to complicated endodontic cases, as



Dr Kim Lemberg

DDS, PhD,
Specialist in Oral and
Maxillofacial Radiology
West Vantaa Dental Clinic, Finland

Optimal image quality for every single field of dentistry

"I've been using Planmeca ProMax 3D Classic ever since its introduction to the market in 2007, and have used it for all imaging purposes. The image quality has proven to be reliable in every single field of dentistry, even in the most demanding imaging cases. The unit is very user-friendly, and all in all the imaging process can be carried out in an uncomplicated manner.

The Planmeca Romexis software is, in my opinion, the best software on the market when it comes to 3D imaging."

you can notice everything in a 3D volume. It is also excellent for cases of wisdom teeth that have grown at a cumbersome angle.

The image quality produced by Planmeca ProMax 3D Classic is excellent. I think it is safe to say that we have the best 3D unit in Finland. This opinion is shared by our surgeons and many radiologists.

The **Planmeca Romexis®** software is a great working tool. It is logical, easy to use, and functions well – just a really good piece of software."

Planmeca CALM™ movement artefact correction	✓
Planmeca Ultra Low Dose™ imaging	✓
Endodontic mode	✓
3D dental programs	✓
3D face photo	✓
3D models scan	✓
Suresmile certification	✓
2D panoramic imaging	✓
Cephalometric imaging, scanning	✓
Cephalometric imaging, one-shot	✓

Volume sizes

Ø80 x 80 mm
Ø80 x 50 mm
Ø50 x 80 mm
Ø50 x 50 mm
extended volume: Ø110 x 80
2x Ø80 x 80 mm
3x Ø80 x 80 mm

The extended volume size increases the diameter from Ø80 x 80 mm to Ø110 x 80 mm. It captures a larger diagnostic area without increasing the patient dose.

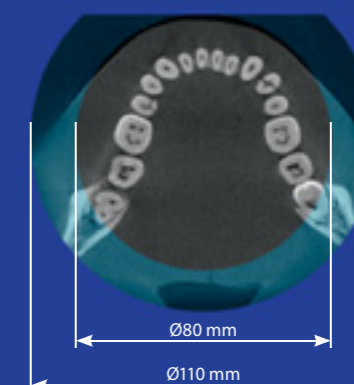

Planmeca ProMax® 3D Plus



German oral surgery practice is impressed with the image quality of Planmeca ProMax® 3D Plus

Dr. Dirk Ladig

Oral surgery practice,
Hoyerswerda, Germany

"I have been using the Planmeca ProMax® 3D Plus unit in my oral surgery practice since 2013. Before that, I had good experience with Planmeca X-ray units. My panoramic X-ray unit ran smoothly for 19 years, the service was good and I was satisfied. Moreover, in 2000, I integrated cone beam computed tomography into my practice by adding a second unit. The decisive factor in purchasing the Planmeca ProMax 3D Plus unit was the radiographs of the new flat-panel devices shown to me by colleagues. The higher resolution of the images was very impressive! There was also a change in the physical layout of my practice. Instead of having two X-ray rooms, I wanted to have one. Planmeca ProMax 3D Plus combines two devices in one: OPG and CBCT. As a result, we need considerably less space.

More information in a single image

I use the device for different kinds of treatment planning; mainly implant cases, but also high-risk wisdom tooth surgery. In my view, a key benefit of the Planmeca ProMax 3D Plus is the possibility of displaying the entire mandible – including the ascending mandibular ramus and mandibular joint – in a single image. I also use the images for diagnosis of foreign body location, apical variances and inflammatory processes in the jaw area. CBCT provides much better diagnostic options for screening for infectious foci in patients with unclear symptoms or certain systemic diseases. Questions related to orthodontic treatments of impacted and displaced teeth, for example, can be easily solved on behalf of colleagues.



Low radiation exposure with adjustable volume sizes

What I really like about the unit is that I can select the volume according to the required image. The radiation exposure for patients is thus kept as low as possible. I use low-dose scans particularly with orthodontic diagnosis. The layer lights are especially useful when centring the image volume.

Operating and adjusting the unit is easy. What's more, the transition from analogue to digital control went well. Since the patients stand upright within the unit, positioning them is much easier than with the predecessor of the CBCT model (with patient bench), without having any problems with motion blur. The new device is also much more pleasant for the patients because there is no feeling of constriction."

Planmeca CALM™ movement artefact correction	✓
Planmeca Ultra Low Dose™ imaging	✓
Tube voltage option 120 kV	✓
Endodontic mode	✓
3D dental programs	✓
3D ENT programs	✓
3D face photo	✓
3D models scan	✓
2D panoramic imaging	✓
Cephalometric imaging, scanning	✓
Cephalometric imaging, one-shot	✓

Volume sizes

Ø200 x 100 mm
Ø200 x 60 mm
Ø160 x 100 mm
Ø160 x 60 mm
Ø100 x 100 mm
Ø100 x 60 mm
Ø80 x 80 mm
Ø80 x 50 mm
Ø40 x 80 mm
Ø40 x 50 mm



Planmeca ProMax® 3D Mid



Italian A&P Clinic opts for Planmeca ProMax® 3D Mid after a thorough market analysis

**Dr Carlo Pizzo, DDS &
Dr Gioia Amico, DDS**

**A&P Clinic
Cittadella, Italy**

"In our new dental clinic, we have been using Planmeca ProMax® 3D Mid – and we are really satisfied with it.

We chose the unit after a thorough analysis of what the market was offering. We needed an imaging unit that could provide a wide range of FOV choices, the possibility to take panoramic images and cephalometric shots, and last but not least, software that could run natively on Mac OS, because our IT infrastructure was entirely built on Apple computers. The only unit that fulfilled all of these requirements was Planmeca ProMax 3D Mid."

For every clinical application

"We love using it for taking panoramic images, preliminary treatment planning, 3D scans, wisdom teeth extractions and implant surgery. With Planmeca Romexis® – its dedicated software – we can virtually place the exact dental implants we are going to use by choosing them from the integrated 3D implant library. This feature works amazingly well."

3D magic with the latest technology

"The machine and the software work seamlessly together: they are fast, reliable and easy to use. The 3D rendering is an incredibly powerful tool for us – for visualising the real bone morphology of the patients, and for the patients themselves to understand their clinical situation and the treatment we are offering them.



So Planmeca Romexis can become a really effective communication tool. For this reason, we adopted also the Planmeca ProFace® option. By superimposing a 3D scan of the patient's face and a CBCT X-ray image, we can show our clients an easy-to-understand image, in which they can really recognize themselves. Even today, this looks like magic for many of our patients!"

Planmeca CALM™ movement artefact correction	✓
Planmeca Ultra Low Dose™ imaging	✓
Tube voltage option 120 kV	✓
Endodontic mode	✓
3D dental programs	✓
3D ENT programs	✓
3D face photo	✓
3D models scan	✓
Suresmile certification	✓
4D jaw motion	✓
2D panoramic imaging	✓
Cephalometric imaging, scanning	✓
Cephalometric imaging, one-shot	✓

Volume sizes

- Ø200 x 170 mm
- Ø200 x 100 mm
- Ø200 x 60 mm
- Ø160 x 170 mm
- Ø160 x 160 mm
- Ø160 x 100 mm
- Ø160 x 60 mm
- Ø100 x 100 mm
- Ø100 x 60 mm
- Ø80 x 80 mm
- Ø80 x 50 mm
- Ø40 x 80 mm
- Ø40 x 50 mm



Planmeca ProMax® 3D Max



Radiologist praises the versatility of Planmeca ProMax® 3D Max

Dr Gazzero

Studio Gazzero
Genoa, Italy

"I was the first Planmeca ProMax® 3D Max user in Italy. Before that, I used Planmeca ProMax® 3D Classic 8x8 for 2 years. And I've been using Planmeca equipment since 1995 because of their image quality, their reliability, and the fast maintenance service.

I really enjoy working with Planmeca ProMax 3D Max. I have used it for every possible dental case, including all aspects of implantology, as well as endodontics, examining alterations of the bone structure, wisdom tooth extractions, supernumerary teeth and more. In ENT cases, I have used the unit for the study of the paranasal sinuses and facial bone structures.

One of the most remarkable advantages is the possibility to choose the image quality and therefore to optimise the patient dose. The volume selection is complete, the imaging programs are easy to use and patient positioning is effortless."



Planmeca CALM™ movement artefact correction	✓
Planmeca Ultra Low Dose™ imaging	✓
Tube voltage option 120 kV	✓
Endodontic mode	✓
3D dental programs	✓
3D ENT programs	✓
3D face photo	✓
3D models scan	✓
Suresmile certification	✓
4D jaw motion	✓
2D panoramic imaging	✓

Volume sizes

Ø230 x 260 mm
Ø230 x 160 mm
Ø230 x 100 mm
Ø230 x 60 mm
Ø130 x 160 mm
Ø130 x 130 mm
Ø130 x 100 mm
Ø130 x 90 mm
Ø130 x 55 mm
Ø100 x 130 mm
Ø100 x 90 mm
Ø100 x 55 mm
Ø50 x 55 mm



Planmeca Romexis® – one software for all your needs

We offer a revolutionary all-in-one software solution for clinics of all sizes. Our world-leading Planmeca Romexis® software is the brains behind all of our products, bringing together all the devices at your dental clinic from CAD/CAM to imaging devices and dental units. The easy-to-use Romexis supports the most versatile range of 2D and 3D imaging modalities.

Mac and
Windows
compatible



The most advanced 3D software

Our pioneering **Planmeca Romexis**® software offers specially designed tools for implantologists, endodontists, periodontists, prosthodontists, orthodontists, maxillofacial surgeons, and radiologists. You can also view your images wherever you are using our mobile apps, and enjoy unmatched compatibility with other systems.

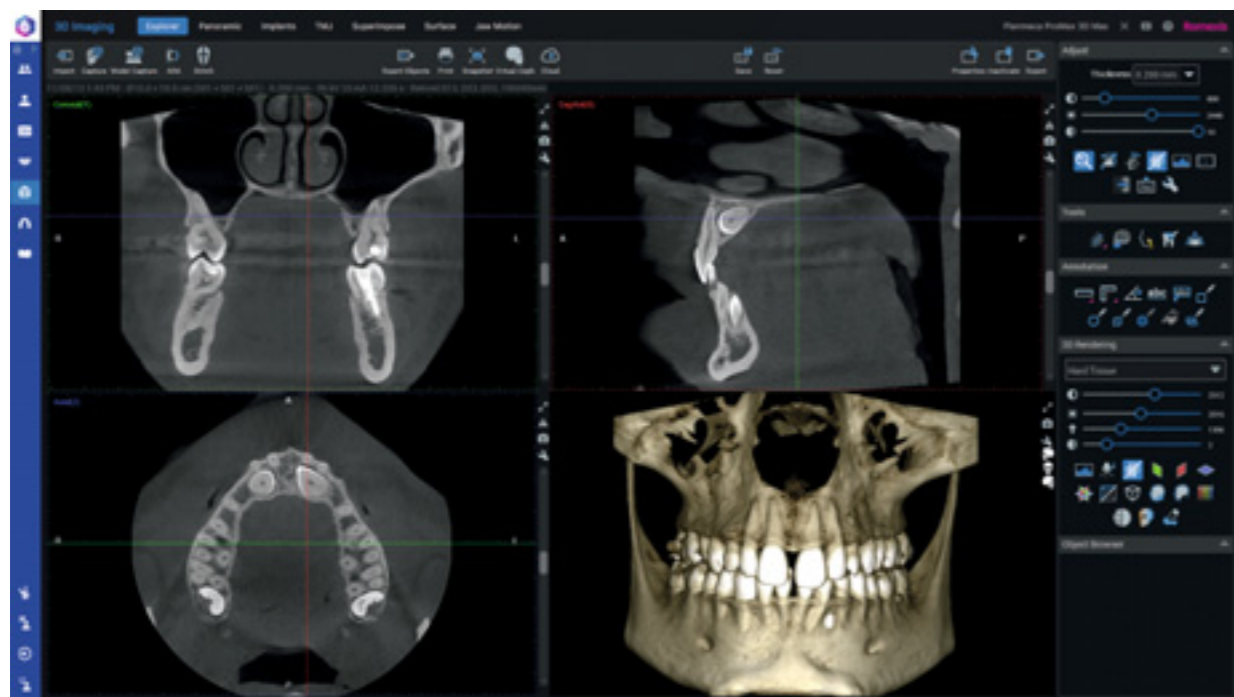

Excellent tools for quality images

With a complete set of tools for image viewing, enhancement, measurement, drawing and annotations, **Planmeca Romexis**® improves the diagnostic value of radiographs. Versatile printing and image import and export functionalities are also included. The software consists of different modules – so you can choose those most suited to your needs.

Convenient 3D diagnosis

The Planmeca Romexis 3D rendering view gives an immediate overview of the anatomy and serves as an excellent patient education tool. The images can be instantly viewed from different projections or converted into panoramic images and cross-sectional slices. Measuring and annotation tools – such as nerve canal tracing – assist in safe and accurate treatment planning.

Best compatibility with other systems

Planmeca Romexis offers excellent compatibility with other systems, allowing you to freely use third-party products at your clinic. TWAIN support and DICOM standard compliance ensure that our flexible software can be used effortlessly with most systems.



Tampere University Hospital, Medical Imaging Center, Finland

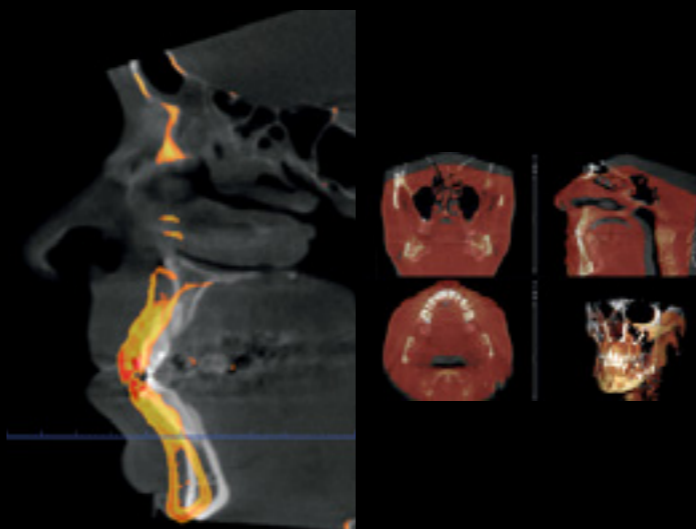

Superimpose CBCT

Planmeca Romexis allows the superimposition of two CBCT images. It is a valuable tool for before-and-after comparisons and can be used for orthognathic surgery follow-ups, as well as orthodontic treatments, for example.

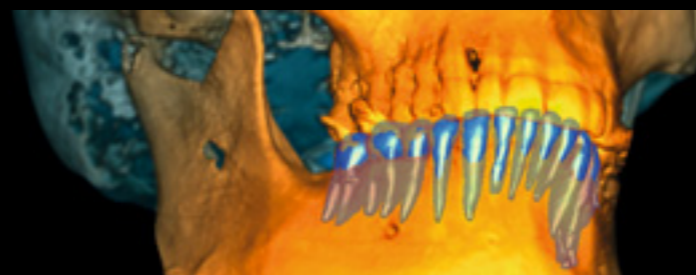

Tooth segmentation

Planmeca Romexis provides an intuitive and efficient tool for segmenting a tooth and its root from a CBCT image. Surface models of segmented teeth can be visualised, measured and utilised e.g. in **Planmeca Romexis**® 3D Ortho Studio as part of orthodontic treatments.



Shaping tool for 3D face photo

The shaping tool allows for free modification of **Planmeca ProFace**® surfaces to simulate effects of treatments or surgery, for example.

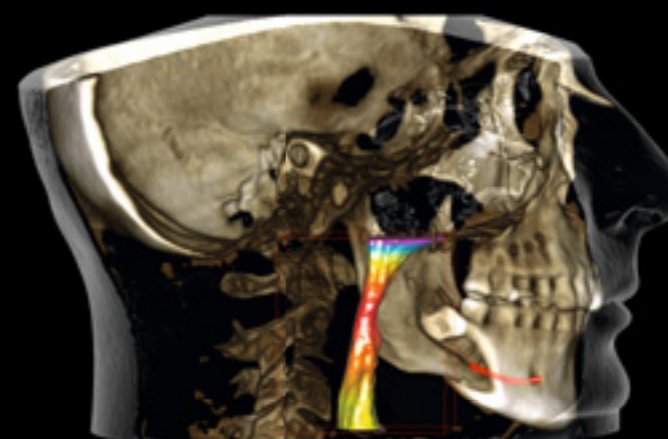

Airways visualisation

Visualise and measure airways and sinus volumes before and after treatment for simplified diagnosis and treatment planning. Our advanced software tools allow accurate measurements in 3D space. Measurements can easily be reviewed using the saved views.

The complete implant workflow

Our **Planmeca Romexis® 3D Implant Planning** module offers all the necessary tools for fully digital implantology – from planning to guided surgery. The software's implant library includes realistic implant models as well as collections of sleeves for guided surgery. After completing the implant plan, a surgical guide can be immediately designed in the same **Planmeca Romexis®** software with just a few clicks.

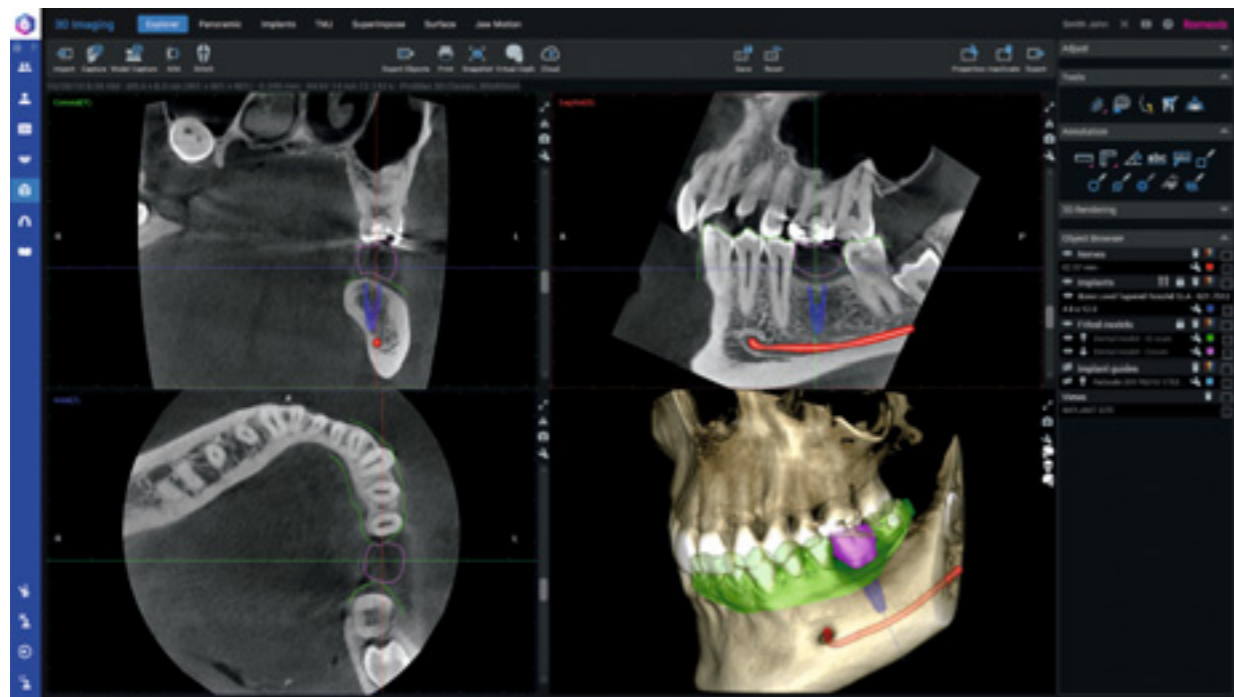

The **Planmeca Romexis®** software platform provides the perfect environment for top-down implant planning. By superimposing a crown and dental model onto CBCT data, users can create a complete virtual setup for optimally positioning the implant – taking prosthodontic and surgical perspectives into account.

Realistic implant models from over 80 manufacturers

See a constantly growing list of all the implants included in the Romexis implant library at planmeca.com/Romexisimplantlibrary

Top-down implant workflow



Mark the nerve on the CBCT image

Superimpose the 3D model scan onto the CBCT image with the Planmeca Romexis® software



Use the Planmeca Romexis® crown library, or import a patient-specific crown from the CAD system to the software

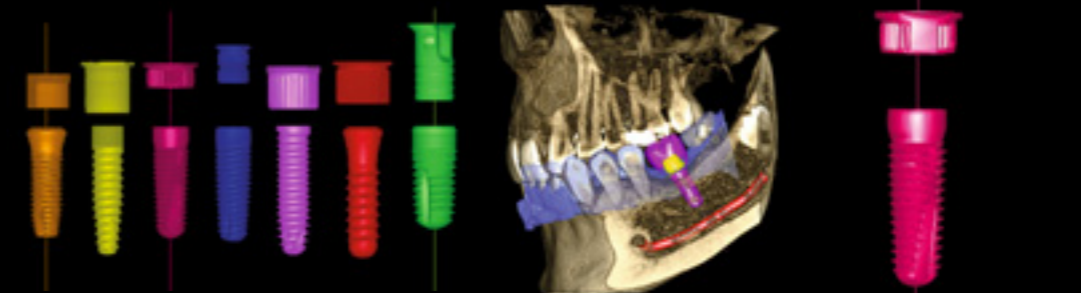

Select the preferred implant and sleeve from the extensive Planmeca Romexis® library and find the optimal position for it from a prosthetic and surgical perspective



Design the surgical implant guide with just a few clicks in Planmeca Romexis® – the software will create an open STL file of the design

Romexis allows designing both tooth- and mucosa-supported guides.



Print the surgical guide with Planmeca Creo™ C5 or any other suitable 3D printer.

Share images and expertise online

Planmeca Romexis® Cloud is a secure image transfer service for Planmeca Romexis® users and their partners for sharing image and patient data with any specialist or patient. You can share images and expertise securely with all partners who use Planmeca Romexis, the free Planmeca Romexis® Viewer, or the Planmeca mRomexis™ mobile tablet application.

Versatile possibilities for communication

- External applications, CDs and DVDs are history – images can now be sent directly from Planmeca Romexis®
- The Romexis software and a Planmeca Romexis® Cloud subscription are required to send new cases – recipients only need an email account
- Dental labs can receive CAD/CAM cases without additional software
- Cases can also be viewed with the Planmeca Romexis® Viewer or Planmeca mRomexis™ applications

Visit online.planmeca.com to subscribe and start sending images now.

Receive cases with free Planmeca Romexis® Viewer application

Planmeca Romexis Viewer is a free application that can be exported and sent together with images from Planmeca Romexis.

- Full-featured viewer application
- No installation required
- Mac and Windows support
- Distribute to specialists or patients

Visit planmeca.com/Viewer for downloading Planmeca Romexis Viewer software.



Increased flexibility with Planmeca mRomexis™ tablet application

Use our fast, easy, and light Planmeca mRomexis mobile imaging application to view all your images in the Planmeca Romexis database on a local network, or to carry images with you on your tablet device. You can also use the application to capture 2D X-ray images with Planmeca equipment, or to take photos with the tablet camera.

Download the Planmeca mRomexis application for iOS and Android from the [App Store](#) or [Google Play](#).

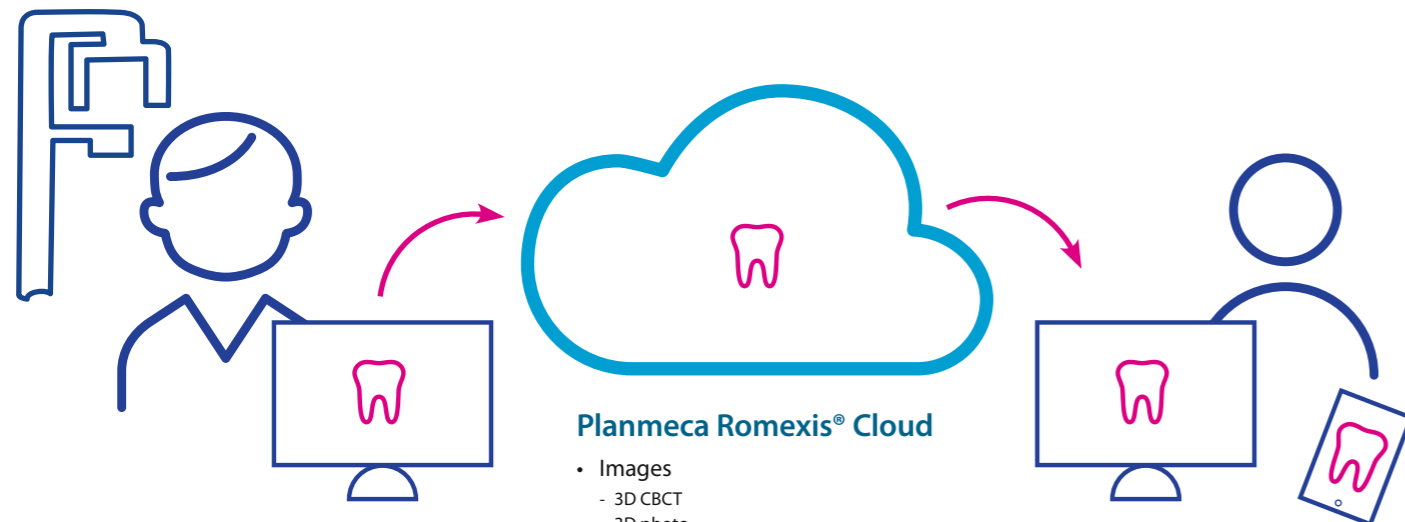

Planmeca Romexis® user

- Radiology center
- General practice

- Images
 - 3D CBCT
 - 3D photo
 - 3D surface scan
 - Panoramic
 - Cephalometric
 - Intraoral
 - Photo
- Referrals
- Interpretations
- Treatment plans

Anybody, anywhere

- General practitioner
- Colleague
- Radiologist
- Specialist
- Dental lab
- Patient

Access to unique X-ray device data

Take the efficiency of your clinic to the next level with real-time information on networked equipment usage and events. Our Romexis® Clinic Management software offers several quality assurance and service benefits for local users, whereas Romexis® Insights allows you to remotely monitor your clinic from anywhere.

Planmeca equipment can be networked to gather valuable data on their use.

- Detailed X-ray log book with dosage and sensor information
- Meet regulatory requirements with automatic recording of image exposure values: kV and mAs
- Enhanced operational planning – exposure counts and modality distribution
- Enhance operational planning – usage hours
- Use detailed event logs to improve quality assurance – including radiation hygiene
- Maximise equipment uptime with fast and accurate trouble-shooting



Stand out with colour

Complement the splendid design of your Planmeca ProMax® 3D X-ray unit by giving it a personal touch with your favourite colours. Select the perfectly matching shades from our exquisite and inspiring collection and create the looks of your dreams!



Technical specifications

Technical data

	ProMax 3D s	ProMax 3D Classic	ProMax 3D Plus	ProMax 3D Mid	ProMax 3D Max	Viso G5 or Viso G7
Anode voltage	60–90 kV	60–90 kV	60–90 kV 60–120 kV	60–90 kV 60–120 kV	60–96 kV* 60–120 kV**	60–120 kV
Anode current	1–14 mA	1–14 mA	1–14 mA	1–14 mA	1–12 mA	1–16 mA
Focal spot	0.5 mm, fixed anode	0.5 mm, fixed anode	0.5 mm, fixed anode	0.5 mm, fixed anode	*0.6 mm, fixed anode **0.5 mm, fixed anode	0.5 mm, fixed anode
Image detector	Flat panel	Flat panel	Flat panel	Flat panel	Flat panel	Flat panel
Image acquisition	Single 200 degree rotation	Single 200 degree rotation	200 / 360 degree rotation	200 / 360 degree rotation	210 / 360 degree rotation	200 / 360 degree rotation
Scan time	7.5–27 s	9–37 s	9–33 s	9–33 s	9–40 s	1–36 s
Typical reconstruction time	2–25 s	2–25 s	2–30 s	2–55 s	2–55 s	2–55 s

Comparison

	ProMax 3D s	ProMax 3D Classic	ProMax 3D Plus	ProMax 3D Mid	ProMax 3D Max	Viso G5 or Viso G7
Planmeca CALM™ movement artefact correction	Yes	Yes	Yes	Yes	Yes	Yes
Planmeca Ultra Low Dose™ imaging	Yes	Yes	Yes	Yes	Yes	Yes
Tube voltage	90 kV	90 kV	90 kV/120 kV	90 kV/120 kV	96 kV/120 kV	120 kV
Endodontic mode	Yes	Yes	Yes	Yes	Yes	Yes
3D dental programs	Yes	Yes	Yes	Yes	Yes	Yes
3D ENT programs	-	-	Yes	Yes	Yes	Yes
3D face photo	Yes	Yes	Yes	Yes	Yes	Yes
3D models scan	Yes	Yes	Yes	Yes	Yes	Yes
Suresmile certification	-	Yes	-	Yes	Yes	-
4D jaw motion	-	-	-	Yes	Yes	Yes
2D panoramic imaging	Yes	Yes	Yes	Yes	Yes	Yes
Cephalometric imaging, scanning	Yes	Yes	Yes	Yes	-	-
Cephalometric imaging, one-shot	Yes	Yes	Yes	Yes	-	Yes

Maximum volume sizes

	ProMax 3D s	ProMax 3D Classic	ProMax 3D Plus	ProMax 3D Mid	ProMax 3D Max	Viso G5	Viso G7
Maximum volume without stitching	Ø50 x 80 mm or Ø80 x 50 mm	Ø80 x 80 mm	Ø200 x 100 mm	Ø200 x 100 mm	Ø230 x 160 mm	Ø200 x 100 mm	Ø300 x 190 mm
Extended volume without stitching		Ø110 x 80 mm					
Maximum volume with horizontal stitching	150 x 100 x 50 mm or 90 x 60 x 80 mm	150 x 100 x 80 mm					
Maximum volume with vertical stitching				Ø200 x 170 mm	Ø230 x 260 mm	Ø200 x 170 mm	Ø300 x 300 mm

Dental programs

Volume size (child mode) [mm]

	ProMax 3D s	ProMax 3D Classic	ProMax 3D Plus	ProMax 3D Mid	ProMax 3D Max	Viso G5	Viso G7
Tooth	Ø50 x 50 (Ø42 x 42) Ø50 x 80 (Ø42 x 68)	Ø50 x 50 (Ø42 x 42) Ø50 x 80 (Ø42 x 68)	Ø40 x 50 (Ø34 x 42) Ø40 x 80 (Ø34 x 68)	Ø40 x 50 (Ø34 x 42) Ø40 x 80 (Ø34 x 68)		Ø30 x 30 – Ø60 x 60 Default: Ø50 x 50	Ø30 x 30 – Ø60 x 60 Default: Ø50 x 50
Teeth	Ø80 x 50 (Ø68 x 42)	Ø80 x 50 (Ø68 x 42) Ø80 x 80 (Ø68 x 68) extended volume: Ø110 x 80	Ø80 x 50 (Ø68 x 42) Ø80 x 80 (Ø68 x 68) Ø100 x 60 (Ø85 x 50) Ø100 x 100 (Ø85 x 85)	Ø80 x 50 (Ø68 x 42) Ø80 x 80 (Ø68 x 68) Ø100 x 60 (Ø85 x 50) Ø100 x 100 (Ø85 x 85)	Ø100 x 55 (Ø85 x 50) Ø100 x 90 (Ø85 x 75)	Ø70 x 30 – Ø90 x 90 Default: Ø90 x 90	Ø70 x 30 – Ø120 x 100 Default: Ø100 x 100
• double scan	2x Ø50 x 50 (Ø42 x 42) 2x Ø50 x 80 (Ø42 x 68) 2x Ø80 x 50 (Ø68 x 42)	2x Ø80 x 80 (Ø68 x 68)					
• triple scan	3x Ø50 x 50 (Ø42 x 42) 3x Ø50 x 80 (Ø42 x 68) 3x Ø80 x 50 (Ø68 x 42)	3x Ø80 x 80 (Ø68 x 68)					
Jaw			Ø160 x 60 (Ø160 x 60) Ø160 x 100 (Ø160 x 100) Ø200 x 60 (Ø200 x 60) Ø200 x 100 (Ø200 x 100)	Ø160 x 60 (Ø160 x 60) Ø160 x 100 (Ø160 x 100) Ø200 x 60 (Ø200 x 60) Ø200 x 100 (Ø200 x 100)	Ø130 x 55 (Ø110 x 50) Ø130 x 90 (Ø110 x 75) Ø230 x 60 Ø230 x 100	Ø100 x 30 – Ø200 x 100 Default: Ø140 x 100	Ø130 x 30 – Ø170 x 170 Default: Ø140 x 100
Face				Ø160 x 160 Ø200 x 170 (Ø200 x 170)	Ø100 x 130 (Ø85 x 110) Ø130 x 130 (Ø110 x 110) Ø130 x 160 (Ø110 x 136)	Ø140 x 140 – Ø200 x 170 Default: Ø160 x 160	Ø140 x 140 – Ø260 x 200 Default: Ø160 x 160
Skull					Ø230 x 160 Ø230 x 260		Ø200 x 220 – Ø300 x 300 Default: Ø240 x 160

ENT (Ear, Nose, Throat) programs

Volume size (child mode) [mm]

	3D Plus	3D Mid	3D Max	Viso G5	Viso G7
Nose	Ø80 x 80 (Ø68 x 68)	Ø80 x 80 (Ø68 x 68)	Ø100 x 90 (Ø85 x 75)	Ø70 x 30 – Ø90 x 90 Default: Ø80 x 80	Ø70 x 70 – Ø120 x 100 Default: Ø80 x 80
Sinus	Ø100 x 100 (Ø100 x 100) Ø160 x 100 (Ø160 x 100) Ø200 x 100 (Ø200 x 100)	Ø100 x 100 (Ø100 x 100) Ø100 x 170 (Ø100 x 170) Ø160 x 100 (Ø160 x 100) Ø160 x 170 (Ø160 x 170) Ø200 x 100 (Ø200 x 100) Ø200 x 170 (Ø200 x 170)	Ø100 x 90 Ø100 x 130 Ø130 x 100 Ø130 x 130 Ø130 x 160	Ø140x140 – Ø200x170 Default: Ø160 x 140	Ø140 x 140 – Ø240 x 190 Default: Ø160 x 140
Middle ear	Ø40 x 50 (Ø34 x 42) Ø80 x 80 (Ø68 x 68)	Ø40 x 50 (Ø34 x 42) Ø80 x 80 (Ø68 x 68)	Ø50 x 55 (Ø42 x 50)	Ø30x30 – Ø60x60 Default: Ø50 x 50	Ø30 x 30 – Ø60 x 60 Default: Ø50 x 50
Temporal bone	Ø80 x 80 (Ø68 x 68)	Ø80 x 80 (Ø68 x 68)	Ø100 x 90 (Ø85 x 75)	Ø70 x 30 – Ø90 x 90 Default: Ø80 x 80	Ø70 x 70 – Ø120 x 100 Default: Ø80 x 80
Vertebrae	Ø80 x 80 (Ø68 x 68)	Ø80 x 80 (Ø68 x 68)	Ø100 x 90 (Ø85 x 75) Ø100 x 130 (Ø85 x 110)	Ø70 x 30 – Ø90 x 90 Default: Ø80 x 100	Ø70 x 70 – Ø120 x 100 Default: Ø80 x 100
Airways	Ø80 x 80 (Ø68 x 68)	Ø80 x 80 (Ø68 x 68)	Ø100 x 90 (Ø85 x 75) Ø100 x 130 (Ø85 x 110) Ø130 x 130 (Ø110 x 110) Ø130 x 160 (Ø110 x 136)	Ø90 x 80 – Ø110 x 100 Default: Ø90 x 100	Ø70 x 70 – Ø120 x 100 Default: Ø90 x 100

Voxel sizes

Planmeca ProMax 3D: 75 µm*, 100 µm, 150 µm, 200 µm, 400 µm, 600 µm

Planmeca Viso: 75 µm*, 150 µm, 300 µm, 450 µm, 600 µm

*Requires Endodontic imaging licence

Technical specifications

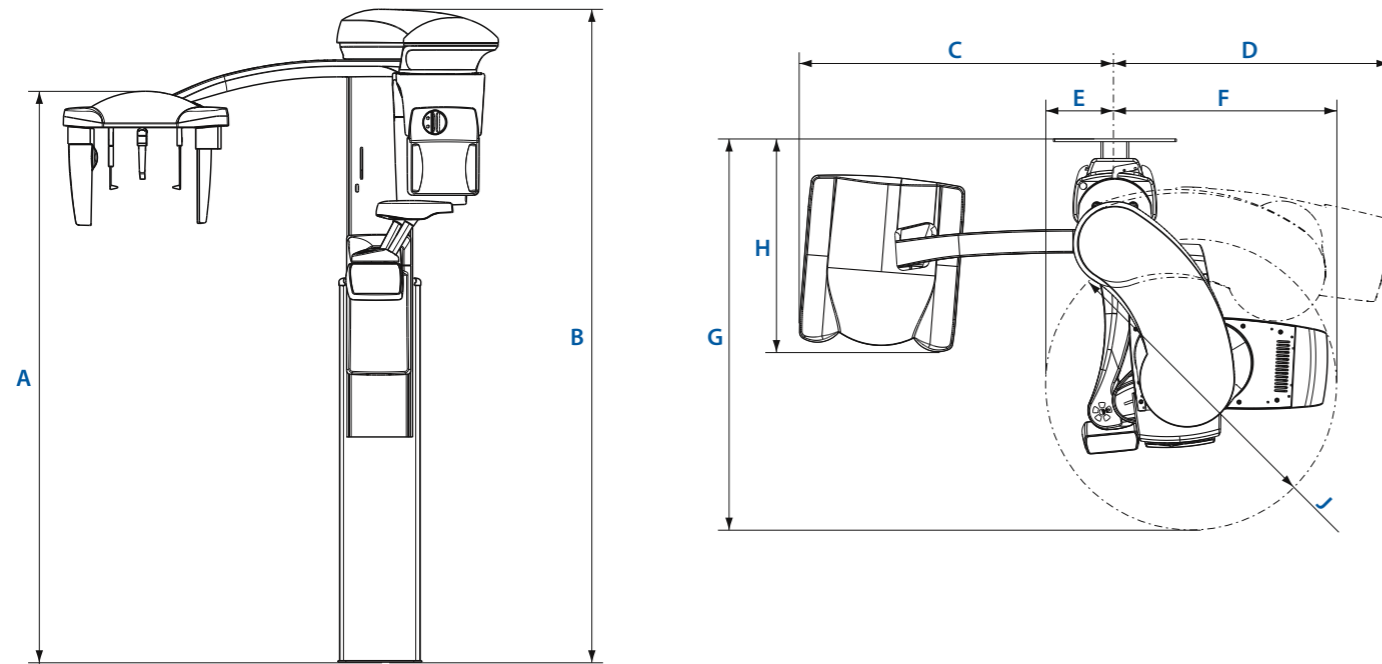

Dimensions

	3D s or 3D Classic	3D Plus or 3D Mid	3D Max	Viso G5 or Viso G7
A	1320–2100 mm (52.0–82.7 in.)	1320–2100 mm (52.0–82.7 in.)	-	1335–2060 mm (52.6–81.1 in.)
B	1560–2340 mm (61.4–92.1 in.)	1730–2390 mm (68.1–94.1 in.)	1730–2390 mm (68.1–94.1 in.)	1635–2360 (64.4–92.9 in.)
C	1170 mm (46.1 in.)	1170 mm (46.1 in.)	-	1115 mm (43.9 in.)
D	850 mm (33.5 in.)	950 mm (37.4 in.)	950 mm (37.4 in.)	960 mm (37.8 in.)
E	150 mm (5.9 in.)	330 mm (13.0 in.)	330 mm (13.0 in.)	425 mm (16.7 in.)
F	698 mm (27.5 in.)	810 mm (32 in.)	788 mm (31 in.)	810 mm (32 in.)
G	1250 mm (49.2 in.)	1430 mm (56.3 in.)	1430 mm (56.3 in.)	1515 mm (59.6 in.)
H	777 mm (30.6 in.)	756 mm (29.8 in.)	-	720 mm (28.3 in.)
J	Ø820 mm (32.3 in.)	Ø1010 mm (39.8 in.)	Ø1010 mm (39.8 in.)	Ø1010 mm (39.8 in.)

Physical space requirements

	3D s or 3D Classic	3D s or 3D Classic with cephalostat	3D Plus or 3D Mid	3D Plus or 3D Mid with cephalostat	3D Max	Viso	Viso G5 or Viso G7 with cephalostat
Width	100 cm (39.4 in.)	202 cm (79.5 in.)	128 cm (50.4 in.)	212 cm (83.5 in.)	128 cm (50.4 in.)	134 cm (53 in.)	206 cm (81 in.)
Depth	125 cm (49 in.)	125 cm (49 in.)	143 cm (56.3 in.)	143 cm (56.3 in.)	143 cm (56.3 in.)	152 cm (60 in.)	152 cm (60 in.)
Height*	156–234 cm (61–92 in.)	156–234 cm (61–92 in.)	173–239 cm (68–94 in.)	173–239 cm (68–94 in.)	173–239 cm (68–94 in.)	164–236 cm (64–93 in.)	164–236 cm (64–93 in.)
Weight	113 kg (lbs 248)	128 kg (lbs 282)	131 kg (lbs 289)	146 kg (lbs 322)	131 kg (lbs 289)	165 kg (lbs 364)	180 kg (lbs 397)

*The maximum height of the unit can be adjusted for offices with limited ceiling space.

Example installation

Included in delivery	Planmeca 3D unit with 3D reconstruction server	
Minimum set up	<p>Client workstation and database server</p> <ul style="list-style-type: none"> Planmeca Romexis 3D Explorer Database server Planmeca Romexis Image Database <p>The client workstation and database server can also be in separate computers.</p>	<p>Ethernet</p>
Additional equipment	<p>Additional diagnostic workstations with different software configurations</p> <p>Planmeca Romexis tools:</p> <ul style="list-style-type: none"> 3D Explorer 3D Cross Sections module 3D TMJ module 3D Implant Planning module DICOM module 	

Planmeca Romexis® imaging software

Supported 2D modalities	<p>Intraoral</p> <p>Panoramic</p> <p>Cephalometric</p> <p>2D linear tomography</p> <p>Photos</p> <p>Stack images (CBCT slices and panoramic slices)</p>
Supported 3D modalities	<p>3D CBCT</p> <p>3D photo</p> <p>3D surface scan</p>
Supported photo sources	<p>Intraoral camera</p> <p>Digital camera or scanner (import or TWAIN capture)</p>
Operating systems	<p>Win 7 Pro (64 bit) / Win 8.1 Pro (64 bit) / Win 10 Pro (64 bit)</p> <p>Win 2008 Server / Win 2012 Server</p> <p>Mac® (OS X or newer)</p> <p>For detailed information please see system requirements of Planmeca Romexis www.planmeca.com</p> <p>*Cephalometric Analysis module, 3D Ortho Studio module and Planmeca PlanCAD Easy are supported on Windows operating systems.</p>
Image formats	<p>JPEG or TIFF (2D images)</p> <p>DICOM (2D and 3D images)</p> <p>STL, OBJ, PLY (3D surface models)</p> <p>TIFF, JPEG, PNG, BMP (imports/exports)</p>
Image size	<p>2D X-ray image: 1–9 MB</p> <p>3D X-ray image: typically 50 MB–1 GB</p>
Installation options	<p>Client–Server</p> <p>Java Web Start deployment</p>
DICOM 3.0 support	<p>DICOM Import/Export</p> <p>DICOM DIR Media Storage</p> <p>DICOM Print SCU</p> <p>DICOM Storage SCU</p> <p>DICOM Storage SCP</p> <p>DICOM Worklist SCU</p> <p>DICOM Query/Retrieve</p> <p>DICOM Storage Commitment</p> <p>DICOM MPPS</p>
Interfaces	<p>TWAIN Client</p> <p>PMBridge (patient information and images)</p> <p>VDDS (patient information and images)</p> <p>InfoCarrier (patient information)</p>
3 rd party software integrations	<p>Dolphin Imaging</p> <p>NobelClinician</p> <p>Simplant</p> <p>Straumann coDiagnostiX</p> <p>Cybermed N-Liten</p> <p>3D Diagnostics service</p> <p>360imaging service</p>

Find all the latest Planmeca news



www.facebook.com/PlanmecaOy



www.planmeca.com/newsroom



Planmeca Oy designs and manufactures a full line of industry-leading dental equipment, including 3D and 2D imaging devices, CAD/CAM solutions, dental care units and software. Planmeca Oy, the parent company of the Finnish Planmeca Group, is strongly committed to better care through innovation, and it is the largest privately held company in the field.

Follow us on social media!



PLANMECA

Asentajankatu 6 | 00880 Helsinki | Finland | tel. +358 20 7795 500 | fax +358 20 7795 555 | sales@planmeca.com | www.planmeca.com

Images may contain optional items not included in standard delivery. Available configurations and features may have country or area specific variations. Some products displayed above may not be available in all countries or areas. Rights for changes reserved.

Planmeca, All in one, Anamat Plus, Cobra, Comfy, DentoVac, Digital perfection, Economat Plus, Elegant, Flexy, Mini-dent, Perio Fresh, PlanEasyMill, Planmeca 4D, Planmeca ActiveAqua, Planmeca AINO, Planmeca ARA, Planmeca CAD/CAM, Planmeca CALM, Planmeca Chair, Planmeca Clarify, Planmeca Compact, Planmeca Creo, Planmeca Emerald, Planmeca FIT, Planmeca Intra, Planmeca iRomexis, Planmeca Lumion, Planmeca Lumo, Planmeca Maximity, Planmeca Minea, Planmeca Minendo, Planmeca Minetto, Planmeca mRomexis, Planmeca Noma, Planmeca Olo, Planmeca Online, Planmeca PlanCAD, Planmeca PlanCAM, Planmeca PlanClear, Planmeca PlanDesk, Planmeca PlanID, Planmeca PlanMill, Planmeca Planosil, Planmeca PlanPure, Planmeca PlanScan, Planmeca PlanView, Planmeca ProCeph, Planmeca ProFace, Planmeca ProLD, Planmeca ProMax, Planmeca ProModel, Planmeca ProOne, Planmeca ProScanner, Planmeca ProSensor, Planmeca ProX, Planmeca Romexis, Planmeca Serenus, Planmeca SingLED, Planmeca SmartGUI, Planmeca Solanna, Planmeca Sovereign, Planmeca Ultra Low Dose, Planmeca Vision, Planmeca Viso, Planmeca Verity, Planmeca Waterline Cleaning System, Planmeca Xtremity, Proline Dental Stool, ProTouch, Saddle Stool, SmartPan, SmartTouch, Trendy, and Ultra Relax are registered or non-registered trademarks of Planmeca in various countries.